



USER MANUAL

Breezy Style

 **Breezy**[®]

P19179

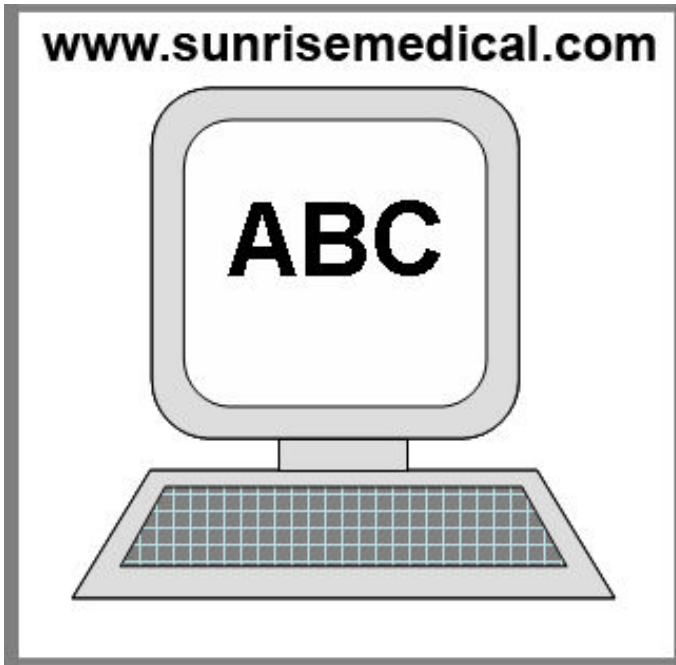

Wheelchair Components

EN 

We at SUNRISE MEDICAL have been awarded the ISO-9001 certificate, which affirms the quality of our products at every stage, from R & D to production. This products meet the requirements in accordance with EC guidelines. Options or accessories shown are available at extra cost.







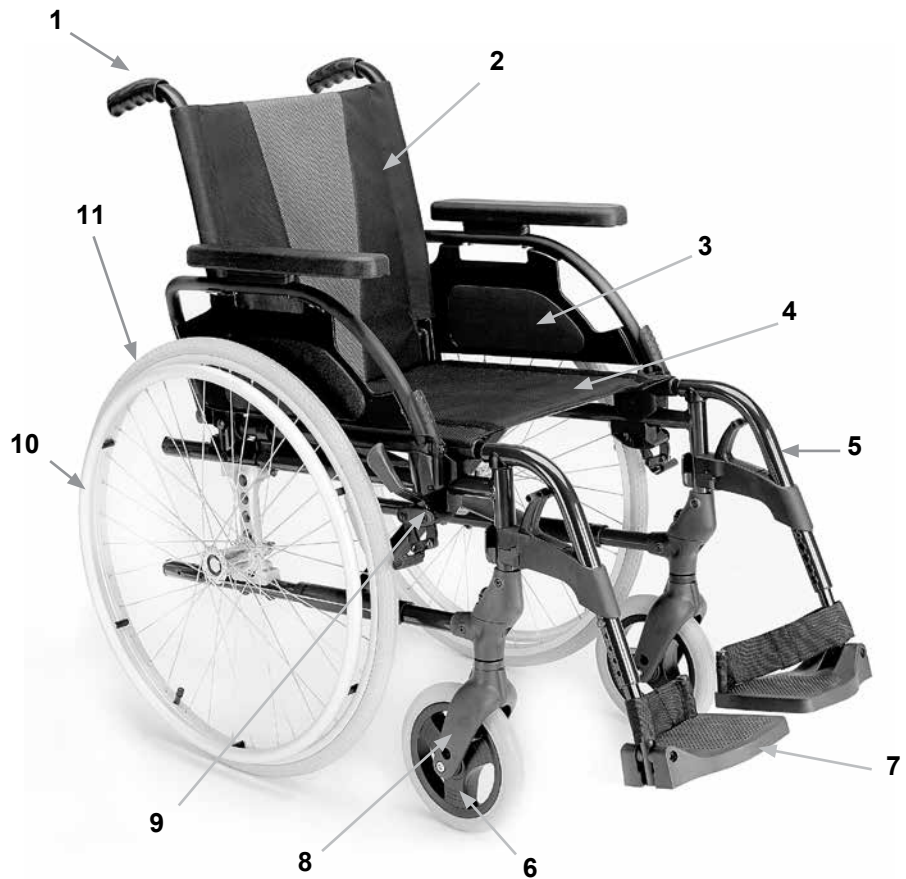



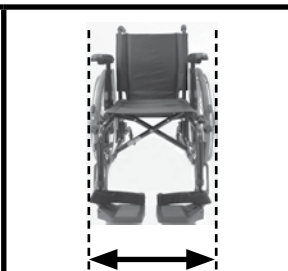
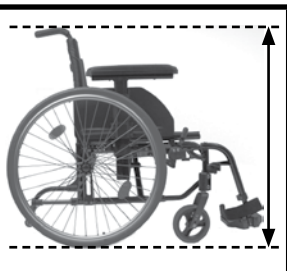
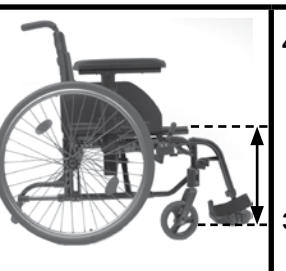
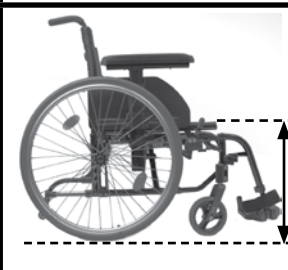

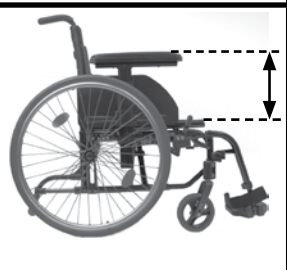
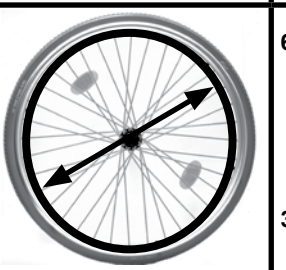
Wheelchairs:

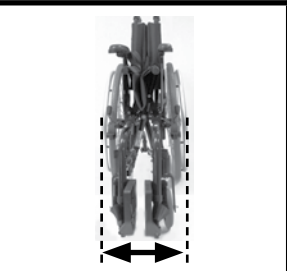
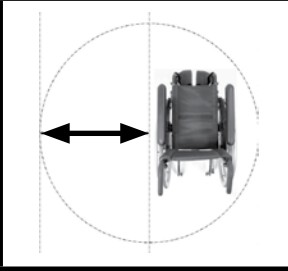
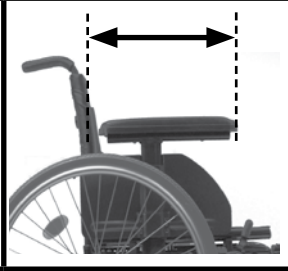
- 1. Push handles
- 2. Backrest upholstery
- 3. Sideguard
- 4. Seat sling
- 5. Footrest
- 6. Castors
- 7. Footboard
- 8. Fork
- 9. Wheel locks
- 10. Handrim
- 11. Rear wheel

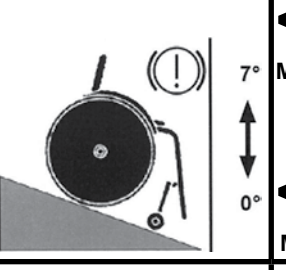
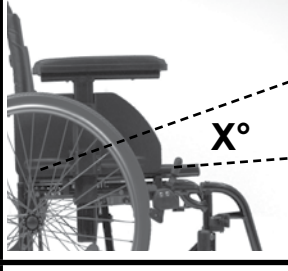
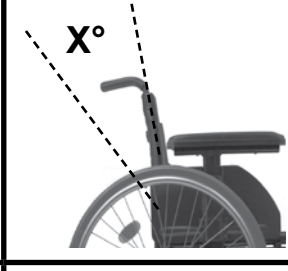
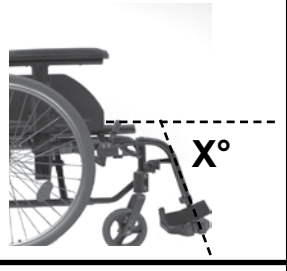
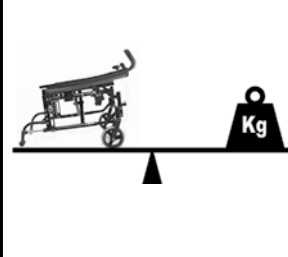
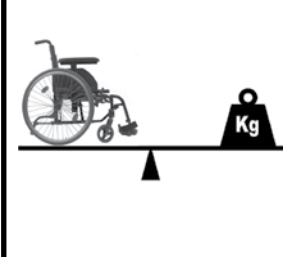

mm  kg 

	1165 ↕ 980		700 ↕ 525		1000 ↕ 880		405 ↕ 345
	515 ↕ 465		450 ↕ 415		265 ↕ 175		600 ↕ 305
	500 ↕ 450		520 ↕ 380		260 ↕		
	940 ↕ 865		360 ↕ 250		25 ↕ -50		MAX mm ↕ MIN mm
	10° ↕ 0°		10° ↕ 0°		10° ↕ 0°		7° ↕ 0° MAX ↕ MIN
	3° ↕		10° (std) ↕ 0-60° (Recliner)		110° ↕ 110°		MAX ↕ MIN
	7.5 ↕		16.5 ↕ 13.9		125 ↕ ---		MAX kg ↕ MIN kg 1.75 KG

ENGLISH



FRONT SEAT HEIGHT : (mm)	465 / 490 / 515
REAR SEAT HEIGHT : (mm)	445 / 470 / 495

Note: The max difference between front and rear seat height is 40 mm

BREEZY STYLE

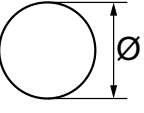
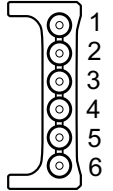
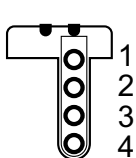
			
465 / 445	24"	3	
490 / 470	24"	4	
515 / 495	24"	5	
465 / 445	22"	4	
490 / 470	22"	5	
515 / 495	22"	6	
465 / 445	12"		2
490 / 470	12"		3
515 / 495	12"		4

BREEZY STYLE

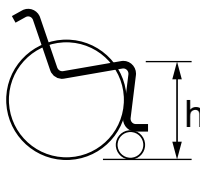
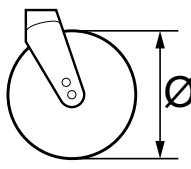
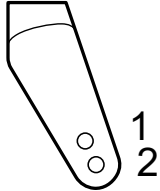
		
465	6"	1
490	6"	2
515	6"	
465	8"	
490	8"	
515	8"	2



Unless otherwise advised, the torque for M6 screws is 7 Nm.
Please refer to page 7 for details

Fig. 25



	Nm
M3	2
M4	3
M5	4
M6	5
M8	10
M10	20
M12	40

Table of Contents

Torque 5
 Definitions 6
 Foreword 7
 Use 7
 Area of application 7
 General safety notes and driving limits 8
 Warranty 10
 Transportability 11
 Handling 13
 Transporting the Wheelchair 13
 Options - Brakes 14
 Options - Footplates 14
 Options - Castors 15
 Options - Backrest 15
 Options – Push handles 16
 Options – sideguard 16
 Options - Anti-Tips 16
 Pelvic Restraint Belt 17
 Options - Crutch holder 18
 Options - Therapy Table 18
 Options – One Hand Operation 18
 Additional Assembly Photographs 18
 Tyres and Mounting 19
 Name Plate 19
 Trouble Shooting 20
 Disposal / Recycling of Materials 20
 Technical Data 21







NOTE:

The wheelchairs shown and described in this user guide may not correspond in every detail exactly to your own model. However, all instructions are completely relevant, regardless of possible detail differences.

The manufacturer reserves the right to alter without notice any weights, measurements or other technical data shown in this manual. All figures, measurements and capacities shown in this manual are approximate, and do not constitute specifications.

Definitions

3.1 Definitions of words used in this manual

Word	Definition
 DANGER!	Advice to the user of Potential Risk of serious injury or death if the advice is not followed
 WARNING!	Advice to the user of a potential risk of injury if the advice is not followed
 CAUTION!	Advice to user that potential damage to equipment may occur if the advice is not followed
NOTE:	General advice or best practice
	Reference To Additional Documentation
	Solid
	Soft tyres
	Does not fit

NOTE:

Please keep a note of your local service agent's address and telephone number in the space provided.

In the event of a breakdown, contact them and try to give all relevant details so they can help you quickly.

Dealer signature and stamp

Foreword

Dear Customer,

We are very pleased that you have decided in favour of a high-quality SUNRISE MEDICAL product.

This Owner's manual will provide numerous tips and ideas so that your new wheelchair can become a trustworthy and reliable partner in your life.

For Sunrise Medical, it is very important that we have a good relationship with our customers. We like to keep you up-to-date about new and current developments at our company. Keeping close to our customers means: fast service, as little red tape as possible, working closely with customers. When you need replacement parts or accessories, or if you just have a question about your wheelchair – we are there for you.

We want you to be satisfied with our products and service. At Sunrise Medical we are constantly working to develop our products further. For this reason, changes can occur in our palette of products with regard to form, technology, and equipment. Consequently, no claims can be construed from the data or pictures contained in this Owner's manual.

The management system of SUNRISE MEDICAL is certified to EN ISO 9001, ISO 13485 and ISO 14001.



As the manufacturer, SUNRISE MEDICAL, declares that the lightweight wheelchairs conform to the 93/42/EEC / 2007/47/EEC guideline.

Please contact your local, authorised SUNRISE MEDICAL dealer if you have any questions regarding the use, maintenance or safety of your wheelchair.

In case there is no authorised dealer in your area, or you have any questions about product safety and product recalls, contact Sunrise Medical either in writing or by telephone or find the information on www.sunrisemedical.co.uk.

Sunrise Medical
Thorns Road
Brierley Hill
West Midlands
DY5 2LD
Phone: 0845 605 66 88
Fax: 0845 605 66 89
www.SunriseMedical.com



DO NOT USE YOUR WHEELCHAIR UNTIL THIS MANUAL HAS BEEN READ AND UNDERSTOOD.

Use

Wheelchairs are exclusively for users who are unable to walk or have limited mobility, for their own personal use, when self-propelling and being moved by a third party (pushed by attendant), within the home and outdoors.

The maximum weight limit (includes the user and any weight of accessories fitted to the wheelchair) is marked on the serial number label, which is affixed to the crossbar or stabiliser bar below the seat.

Warranty can only be taken on if the product is used under the specified conditions and for the intended purposes. The expected life of the wheelchair is 5 years. Please DO NOT use or fit any 3rd party components to the wheelchair unless they are officially approved by Sunrise Medical.

DANGER!

- Do not fit any unauthorized electronic equipment.
- Do not fit powered or mechanically operated mobility devices, drives, hand-bike or any other device that changes the intended use or the structure of the wheelchair.
- Any combination with other medical devices requires approval directly from Sunrise Medical.

Area of application

The variety of fitting variants as well as the modular design mean that it can be used by those who cannot walk or have limited mobility because of:

- Paralysis
- Loss of extremity (leg amputation)
- Extremity defect deformity
- Joint contractures/joint injuries
- Illnesses such as heart and circulation deficiencies, disturbance of equilibrium or cachexia as well as for elderly people who still have strength in the upper body.

When considering provision, please also note the body size, weight, physical and psychological constitution, the age of the person, living conditions and environment.

Operating Conditions

The wheelchair can be used indoors as well as outdoors in self-propelled or attendant configurations, on dry, firm, relatively smooth surfaces. It is not recommended for use in a storm, torrential rain, snow and ice or other extreme weather conditions.

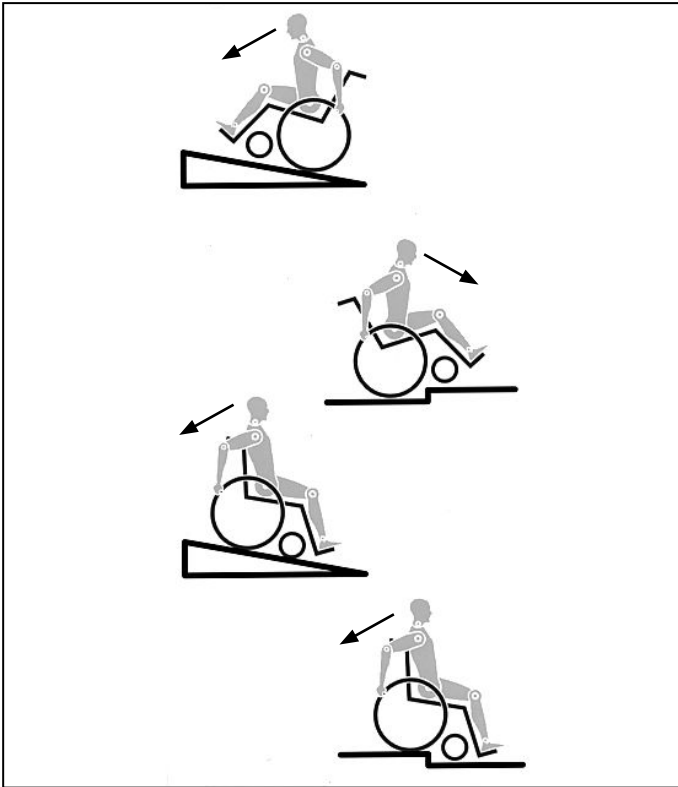

- When getting on or off the wheelchair, do not use the footboards. These should be flipped up beforehand and swung to the outside as far as possible. Always position yourself as close as possible to the place where you wish to sit.
- Only use your wheelchair properly. For example, avoid travelling against an obstacle without braking (step, kerb edge) or dropping down gaps.
- The wheel locks are not intended to brake your wheelchair. They are only there to ensure that your wheelchair does not begin rolling unintentionally. When you stop on uneven ground, you should always use the wheel locks to prevent such rolling. Always apply both wheel locks; otherwise, your wheelchair could tip over.
- Explore the effects of changing the centre of gravity on the behaviour of the wheelchair, for example on inclines, slopes, all gradients or when overcoming obstacles. Do this with the secure aid of a helper.
- With extreme settings (e.g. rear wheels in the most forward position) and less than perfect posture, the wheelchair may tip over even on a level surface.
- Lean your upper body further forward when going up slopes and steps.
- Lean your upper body further back when going down slopes and steps. Never try to climb and descend a slope diagonally.
- Avoid using an escalator which may lead to serious injury in the event of a fall.
- Do not use the wheelchair on slopes > 10°. The Dynamic safe slope is dependent on the chair configuration, the user's abilities and the style of riding. As the user's abilities and style of riding cannot be pre-determined then the max safe slope cannot be determined. Therefore this must be determined by the user with the assistance of an attendant to prevent tipping. It is strongly recommended that inexperienced users have anti-tip tubes fitted.
- It is possible that potholes or uneven ground could cause this wheelchair to tip over, especially when riding uphill or downhill.
- Do not use your wheelchair on muddy or icy ground. Do not use your wheelchair where pedestrians are not allowed.
- To avoid hand injuries do not grab in between the spokes or between the rear wheel and wheel lock when driving the wheelchair.
- In particular when using lightweight metal handdrims, fingers will easily become hot when braking from a high speed or on long inclines.
- Riding sideways on to a slope or incline, increases the possibility of the wheelchair tipping over sideways.
- Only attempt stairs with the help of an attendant. There is equipment available to help you, e.g. climbing ramps or lifts, please use them. If there is no such equipment available, then the wheelchair must be tipped and pushed, never carried, over the steps (2 helpers). We recommend that users over 100 kg in weight do not use this stairway manoeuvre!
- In general, any anti-tip tubes fitted must be set beforehand, so that they cannot touch the steps, as otherwise this could lead to a serious tumble. Afterwards the anti-tip tubes must be set back to their correct position.
- Make sure that the attendant only holds the wheelchair using securely mounted parts (e.g. not on the footrests or the sideguards).
- This wheelchair is not designed to be used whilst weight training and/or when using dumbbells. Only use equipment specifically designed for this purpose.
- Do not lift or carry the wheelchair by the backtubes or the pushhandles.
- When using the lifting ramp make sure that the anti-tip tubes fitted are positioned outside the danger area.
- Secure your wheelchair on uneven ground or when transferring, e.g. into a car, by using the brakes.

The engineering and construction of this wheelchair has been designed to provide maximum safety. International safety standards currently in force have either been fulfilled or exceeded in parts. Nevertheless, users may put themselves at risk by improperly using their wheelchairs. For your own safety, the following rules must be strictly observed.

Unprofessional or erroneous changes or adjustments increase the risk of accident. As a wheelchair user, you are also part of the daily traffic on streets and pavements, just like anyone else. We would like to remind you that you are therefore also subject to any and all traffic laws.

Be careful during your first ride in this wheelchair. Get to know your wheelchair.

Before each use, the following should be checked:

- Quick-release axles on the rear wheels
- Velcro on seats and backrests
- Tyres, tyre pressure and wheel locks.

Before changing any of the adjustments of this wheelchair, it is important to read the corresponding section of the user's manual.

It is possible that potholes or uneven ground could cause this wheelchair to tip over, especially when riding uphill or downhill.

When riding forwards over a step or up an incline, the body should be leaning forward.



- NEVER exceed the maximum load of 125 kg for driver plus any items carried on the wheelchair. Please note the weight information for lighter weight options, which are quoted separately. If you exceed the maximum load, this can lead to damage to the chair, or you may fall or tip over, lose control and may lead to serious injury of the user and other people.
- When it is dark, please wear light clothing or clothing with reflectors, so that you can be seen more easily. Make sure that the reflectors on the side and back of the wheelchair are clearly visible. We would also recommend that you fit an active light.
- To avoid falls and dangerous situations, you should first practice using your new wheelchair on level ground with good visibility.

- If and whenever possible, during a journey in a specially fitted vehicle for disabled people, vehicle occupants should use the seats in the vehicle and the appropriate restraint system. This is the only way to ensure that occupants will have the maximum protection if there is an accident. When using safety elements offered by SUNRISE MEDICAL and using a specially designed safety system, lightweight wheelchairs can be used as a seat when being transported in a specially fitted vehicle. (See the Chapter on “Transportation”).
- Depending on the diameter and setting of the castors, as well as the centre of gravity setting of the wheelchair, the castors may begin to wobble at high speeds. This can lead to the castors being blocked and the wheelchair may tip over. Therefore, please make sure that the castors are adjusted correctly (see the Chapter “Castors”). In particular, do not travel on an incline without brakes, travel at a reduced speed. We recommend that novice users use anti-tip tubes.
- Anti-tip tubes should prevent the chair tipping over backwards unintentionally. Under no circumstances should they take the place of transit wheels, and be used to transport a person in a wheelchair with the rear wheels removed.
- When reaching for objects (which are in front of, to the side or behind the wheelchair) make sure that you do not lean too far out of the wheelchair, as if you change the centre of gravity there is a risk of tipping or rolling over. The hanging of additional load (back pack or similar items) onto your chair backposts can affect the rearward stability of your chair, especially when used in combination with recliner backrests. This can cause the chair to tip backwards causing injury.
- Adjustments to your wheelchair, particularly to safety-related components must be carried out by an approved dealer. This applies to adjustments to wheel locks, anti-tip tubes, backrest angle and height, lower leg length, COG, lap belt, rear wheel toe-in and camber, seat height as well as toe-in and directional stability of the castor fork.
- When using mobility accessories fitted to the wheelchair such as handbikes, electronic power assist, etc, make sure that your wheelchair is fitted with the appropriate castor forks, approved for this use. Please contact your dealer if you have any questions.
- Do not fit any unauthorized electronic equipment, powered or mechanically operated mobility drives, hand-bike or any other device that changes the intended use or the structure of the wheelchair.
- Any combination with other medical devices requires the approval of Sunrise Medical.
- Please note that in certain configurations the wheelchair may exceed a width of 700 mm. If this is the case, under certain circumstances, it may not be possible to use some or all of the available escape routes from a building. It may be more difficult or impossible to travel on public transport.
- Further information and safety instructions can be provided by your authorised dealer.
- For thigh amputees you must use anti-tip tubes.
- Before setting off, check that your tyre pressure is correct. For rear wheels it should be at least 3.5 bar (350 kPa). The max. pressure is indicated on the tyre. The knee-lever brakes will only work if there is sufficient tyre pressure and if the correct setting has been made (see the Chapter on “Brakes”).
- If the seat and back sling are damaged, you must replace them immediately.
- Be careful with fire, in particular with burning cigarettes. Seat and back slings can be set alight.
- If the wheelchair is subject to direct sunlight for a long period of time, then parts of the wheelchair (e.g. frame, legrests, brakes and sideguard) may become hot (>41°C).
- Always make sure that the quick-release axles on the rear wheels are set properly and lock in. If the button on the quick-release axle is not pressed in, the rear wheel cannot be removed.
- Always take care to avoid getting your clothing trapped in the drive wheels.

 **WARNING!**

- The effect of the knee-lever brake as well as the general driving characteristics are dependent on tyre pressure. The wheelchair is significantly lighter and easier to manoeuvre when the rear wheels are pumped up correctly and both wheels have the same pressure.
- Make sure that your tyres have sufficient tread! Please note that you are subject to any and all traffic laws when driving in public traffic.
- Always be careful with your fingers when working or adjusting the wheelchair!

 **WARNING!**

CHOKING HAZARD – This mobility aid uses small parts which under certain circumstances may present a choking hazard to small children.

The wheelchairs shown and described in this user guide may not correspond in every detail exactly to your own model. However, all instructions are completely relevant, regardless of possible detail differences.

The manufacturer reserves the right to alter without notice any weights, measurements or other technical data shown in this manual. All figures, measurements and capacities shown in this manual are approximate and do not constitute specifications.

Sunrise Medical is ISO 9001 certified, which ensures quality at all stages of the development and production of our products. This product complies with the standards set forth in EU directives. Optional equipment and accessories are available at extra charge.

THIS GUARANTEE DOES NOT AFFECT YOUR LEGAL RIGHTS IN ANY WAY.

Sunrise Medical* provides a guarantee, as set out in the warranty conditions, for products to its customers covering the following.

Warranty conditions:

1. Should a part or parts of the product require repair or replacement as a result of a manufacturing and/or material fault within 24 months, then the affected part or parts will be repaired or replaced free of charge. The warranty will only cover manufacturing defects
2. To enforce the warranty, please contact Sunrise Medical Customer Service with the exact details of the nature of the difficulty. Should you be using the product outside the area covered by the Sunrise Medical customer service agent, repairs or replacement will be carried out by another agency as designated by the manufacturer. The product must be repaired by a Sunrise Medical designated Customer Service agent, (dealer).
3. For parts, which have been repaired or exchanged within the scope of this warranty, we provide a warranty in accordance with these warranty conditions for the remaining warranty period for the product in accordance with point 1.
4. For original spare parts which have been fitted at the customer's expense, these will have a 12 months guarantee, (following the fitting), in accordance with these warranty conditions.
5. Claims from this warranty shall not arise, if a repair or replacement of a product or a part is required for the following reasons:
 - a. Normal wear and tear, which include but is not limited to the following parts where fitted; batteries, armrest pads, upholstery, tyres, brakes shoes, ferrules, etc.
 - b. Any overloading of the product, please check the EC label for maximum user weight.
 - c. The product or part has not been maintained or serviced in accordance with the manufacturer's recommendations as shown in the user instructions and/or the service instructions.
 - d. Accessories have been used which are not specified as original accessories.
 - e. The product or part having been damaged by neglect, accident or improper use.
 - f. Changes/modifications have been made to the product or parts, which deviate from the manufacturer's specifications.
 - g. Repairs have been carried out, before our Customer Service has been informed of the circumstances.
6. This guarantee is subject to the law of the country in which the product was purchased from Sunrise Medical“

* Means the Sunrise Medical facility from which the product was purchased.

Additional Notes For Australia Only:

- i. For goods provided by Sunrise medical Pty Ltd in Australia, our goods come with a guarantee by Sunrise Medical that cannot be excluded under Australian Consumer Law.
- ii. You are entitled to a replacement or refund for a major failure and for compensation for any foreseeable loss or damage.
- iii. You are also entitled to have the goods repaired or replaced if the goods fail to be of acceptable quality and the failure does not amount to a major failure.
- iv. The benefits to you given by this warranty are in addition to your other rights and remedies under a law in relation to the goods to which the warranty relates.



There is a risk of serious injury or death if this advice is ignored!

Transportation of your wheelchair within a vehicle:

A wheelchair secured in a vehicle will not provide the equivalent level of safety and security as a vehicle seating system. It is always recommended that the user transfers to the vehicle seating. It is recognised that this is not always practical for the user to be transferred and in these circumstances, where the user must be transported whilst in the wheelchair, the following advice must be followed:

1. Confirm that the vehicle is suitably equipped to transport a passenger in a wheelchair, and ensure the method of access/ egress is suitable for your wheelchair type. The vehicle should have the floor strength to take the combined weight of the user, the wheelchair and accessories.
2. Sufficient space should be available around the wheelchair to enable clear access to attach, tighten and release the wheelchair and occupant tie down restraints and safety belts.
3. The occupied wheelchair must be located in a forward facing position and secured by the wheelchair tie down and occupant restraint straps (WTORS tie downs meeting the requirements of ISO 10542 or SAE J2249) in accordance with the WTORS manufacturer's instructions.
4. The wheelchair's use in other positions within a vehicle has not been tested e.g. transportation in a side facing position must not be carried out under any circumstances (Fig. A).
5. The wheelchair should be secured by a Tie Down Restraint system, conforming to ISO 10542 or SAE J2249 with non-adjustable front straps and adjustable rear straps, which typically use Karabiner clips/S hooks and tongue and buckle fittings. These restraints generally comprise of 4 individual straps that are attached to each corner of the wheelchair.
6. The tie-down restraints should be fitted to the main frame of the wheelchair as indicated in the diagram on the following page, and not to any attachments or accessories, e.g. not around the spokes of wheels, brakes or footrests.
7. The tie-down restraints should be attached as close as possible at an angle of 45 degrees and tightened securely in accordance with the manufacturer's instructions.
8. Alterations or substitutions must not be made to the wheelchair securement points or to structural and frame or components without consulting the manufacturer. Failure to do so will invalidate the ability of a Sunrise Medical wheelchair to be transported within a vehicle.

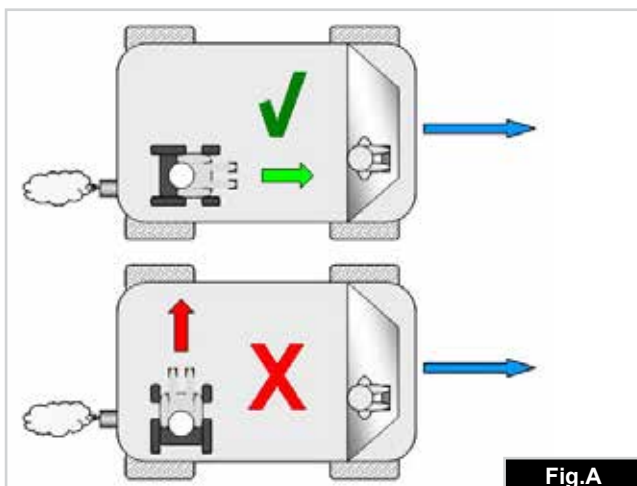

Fig.A

9. Both pelvic and upper torso restraint belts must be used to restrain the occupant to reduce the possibility of head and chest impacts with the vehicle components and serious risk of injury to the user and other vehicle occupants. (Fig B) The upper torso restraint belt should be mounted to the vehicle "B" pillar - failure to do so will increase the risk of serious abdominal injuries to the user.

10. A head restraint suitable for transportation (see label on headrest) must be fitted and suitably positioned at all times during transportation.
11. Postural supports (lap straps, lap belts) should not be used or relied on for occupant restraint in a moving vehicle unless they are labelled as meeting the requirements specified in ISO 7176-19:2001 or SAE J2249.
12. The safety of the user during transportation depends upon the diligence of the person securing the tie-down restraints and they should have received appropriate instructions and/or training in their use.
13. Wherever possible remove and stow safely away from the wheelchair all auxiliary equipment, for example: Crutches, Loose cushions and Tray Tables.
14. Articulating/elevating leg rest should not be used in the elevated position when the wheelchair and user are being transported and the wheelchair is restrained using Wheelchair Transport and Occupant Restraints.
15. Reclining backrests should be returned to an upright position.
16. The manual brakes must be firmly applied.
17. Restraints should be mounted to the vehicle "B" pillar and should not be held away from the body by wheelchair components such as armrest or wheels.

NOTE: The Breezy Style is suitable to be used as a seat in a vehicle only if the transportation kit is fitted to the rear frame. For the UK this kit is fitted as STANDARD, but for other countries, the kit is an OPTION and must be selected from the order form.



- The Transportation kit must be fitted to the wheelchair before using it to transport a passenger within a vehicle.
- The Transportation kit must be fitted by a Sunrise Medical approved dealer.

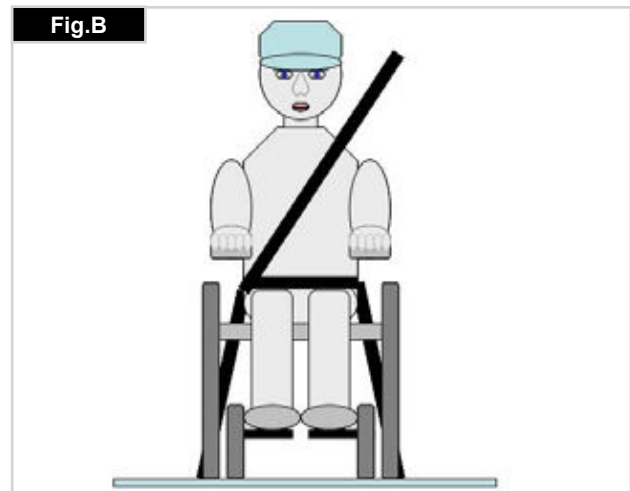

Fig.B

Occupant Restraints Instruction:

1. The pelvic restraint belt must be worn low across the front of the pelvis so that the angle of the pelvic belt is within the preferred zone of 30 to 75 degrees to the horizontal. A steeper (greater) angle within the preferred zone is desirable i.e. closer to, but never exceeding 75degrees. (Fig C)

2. The upper torso restraint belt must fit over the shoulder and across the chest as illustrated Fig d and e
 Restraint belts must be adjusted as tightly as possible consistent with user comfort.
 Restraint belt webbing must not be twisted when in use.
 The upper torso restraint belt must fit over the shoulder and across the shoulder as illustrated in Fig D and E.

3. The attachment points to the chair are the inner front side frame just above the castor, and the rear side frame. The straps are fitted around the side frames at the intersection of the horizontal and vertical frame tubes. (See Figs G-H).

4. The tie down symbol (Fig F) on the wheelchair frame indicates the position of the wheelchair restraint straps. The straps are then tensioned after the front straps have been fitted to secure the wheelchair.

Positioning of wheelchair tie down restraints on wheelchair:

1. Location of the front and rear tie down labels (Fig.G - H).

Minimum User Weight 22 kg:

When the user being transported is a child, less than 22Kg mass and the vehicle involved has less than eight (8) seated passengers it is recommended that they be transferred to an UNCE Regulation 44 compliant child restraint system (CRS).

This type of restraint system provides a more effective occupant restraint system than the conventional 3 point occupant restraint system and some CRS systems also include additional postural supports to assist in maintaining the position of the child when seated.

Parents or care providers may consider the option, in some circumstances, for their child is to remain in their wheelchair whilst in transport due to the level of posture control and comfort provided by the set up in the wheelchair.

We would recommend in such circumstances that a risk assessment be carried out by your healthcare professional and relevant competent persons.

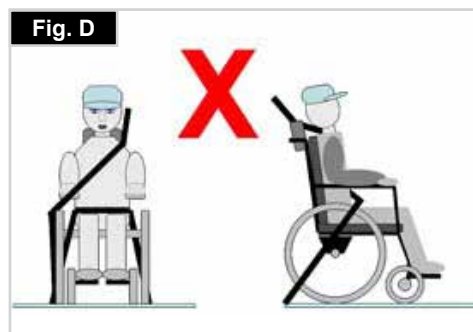
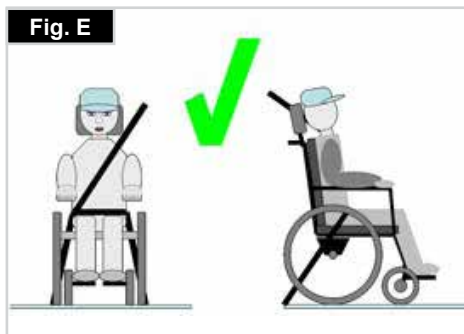
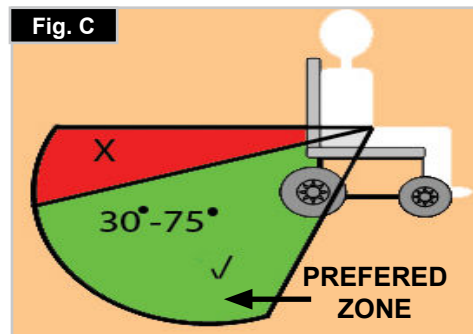

Handling

Folding up

First remove the seat cushion and the back seat shell from the wheelchair and flip up the (platform) footplate or the individual footrests. Take hold of the sling or the seat tubes in the middle, from the back and pull upwards. The wheelchair will then fold up. To fold your wheelchair so that it is as small as possible, e.g., to put into a car, you can remove the footrests (depending on the model). For this purpose, open the latch from the outside and swing the footrest to the side. Then the footrest only has to be drawn out of the receiver tube (Fig. 1.0).



Transportation

To move the mobility aid, the folded wheelchair should be lifted by holding the front part of the cross-brace and the push handles.

Unfolding

Press down on the seat tube (see figure). Your wheelchair is then unfolded. Now snap the seat tubing into position in the seat saddle. This can be facilitated by slightly tipping your wheelchair, as this means that the weight is taken off one of the rear wheels. **Be careful not to get your fingers caught in the cross-tube assembly.** Refit the seat cushion! (Fig. 2.0).



Getting into your wheelchair independently (Fig. 4.0)

- The wheelchair should be pushed up against a wall or solid piece of furniture;
- The brakes should be on;
- The footplates should be hinged up;
- The user can then lower himself into the chair;
- The footplates should then be pushed down and the feet rested on them in front of the heel loops.

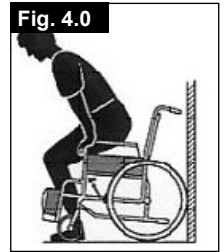

Getting out of your wheelchair independently (Fig. 5.0)

- The brakes should be on;
- The hinged footplates should be hinged up;
- With one hand on each armrest, the person should bend slightly forward to bring the body weight to the front of the seat, and with both feet firmly on the ground, one foot well back, push up into the upright position.

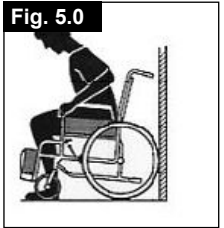

WARNING!

When standing, do not stand on the footplates or the wheelchair will tip up. It is easier and safer to get into your wheel chair if you turn the footplates up and out of the way or take them off the wheelchair.

Transporting the Wheelchair

When transporting the unoccupied wheelchair in a vehicle, it should be tied down or strapped in.

Quick-Release Axles for Rear Wheels (Fig.3.0)

Removing the rear wheels will keep the wheelchair as compact as possible.

The rear wheels are equipped with quick-release axles. The wheels can thus be installed or removed without using tools.

To remove a wheel, simply depress the quick-release button on the axle (1) and pull it out.



CAUTION!

Hold the quick-release button on the axle depressed when inserting the axle into the frame to mount the rear wheels. Release the button to lock the wheel in place. The quick-release button should snap back to its original position.

Options - Brakes

Wheel locks

Your wheelchair is equipped with two wheel locks. They are applied directly against the tyres. To engage, press both brake levers forward against the stops. To release the locks, pull the levers back to their original positions.

Braking power will decrease with:

- Worn tyre tread
- Tyre pressure that is too low
- Wet tyres
- Improperly adjusted wheel locks

The wheel locks have not been designed to be used as brakes for a moving wheelchair. The wheel locks should therefore never be used to brake a moving wheelchair. Always use the hand-rims for braking. Make sure that the gap between the tyres and wheel locks complies with given specifications. To readjust, loosen the screw and set the appropriate gap. Then re-tighten the screw (Fig. 6.0 + 8.0).

CAUTION!

After each adjustment of the rear wheels, check the wheel lock gap and re-adjust if necessary.

Brake lever Extension

The extension for the brake lever can be removed or folded down. The longer lever helps to minimise the effort needed to set the wheel locks (Fig. 7.0).



CAUTION!

Mounting the wheel lock too close towards the wheel will result in a higher effort to operate. This might cause the brake lever extension to break!

CAUTION!

Leaning onto the brake lever extension while transferring will cause the lever to break! Splashing water from tyres might cause the wheel lock to malfunction.

Drum Brakes

Drum brakes permit safe and convenient braking for an attendant. They can also be set with the aid of a locking lever (1) to prevent rolling. The lever must snap audibly into place. Drum brakes are not influenced by air pressure inside the tyres. Your wheelchair cannot be moved when the drum brakes are set (Fig. 7.0).

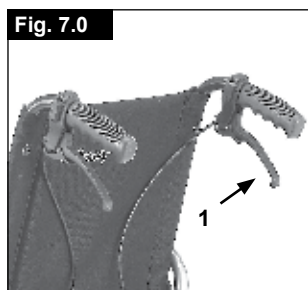

CAUTION!

Drum brakes must only be adjusted by authorised dealers.

Options - Footplates

Footplates:

The footplates can be flipped up to make it easier to transfer to/from the chair.



Lower leg length:

For users with longer legs, the leg support can be lowered to the appropriate level by using the screws (1). Loosen the screws, push the tubes to the desired position and then re-tighten the screws (see section on torque). There must always be a minimum gap of 25mm between the footplates and the ground, (Fig. 8.0).

Footrests and Latch

The legrests can be swung inwards under the seat sling or outwards. When fitting the legrests, the footrests must be pointing inwards or outwards. Then rotate the legrest inwards, until it locks into place. To remove, pull the lever (1), swing the footplate inwards or outwards and then lift the legrest out. Make sure that the legrest is locked into place correctly, (Fig. 9.0).

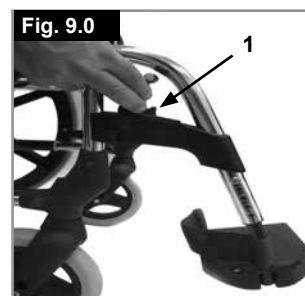

CAUTION!

- The legrests must not be used to lift or to carry the wheelchair.
- When getting on or off the wheelchair, do not use the footboards. These should be flipped up beforehand or the footrest should be swung to the outside as far as possible.

Option Elevating Legrest

(Fig. 10.0-12.0)

To remove, pull the lever (1), swing the footplate outwards and then lift the legrest out.

Height Adjustment:

The lower leg length can be adjusted infinitely by releasing the screw (2). Adjust the suitable height and tighten the screw again.

CAUTION!

The distance between the footplate and the ground must be at least 40 mm.

Angle Adjustment:

Press the lever (3) downward with one hand while supporting the legrest with the other hand to take the load off. When a suitable angle is achieved, let go of the lever and the legrest will lock into one of the preset positions.

CAUTION!

- Keep hands clear of the adjustment mechanism between, the frame and the movable parts of the footrest while elevating or lowering the footrest.
- The footrests should not be used to lift or to carry the wheelchair.
- Risk of trapping fingers!
- When moving the footrest up or down, do not put your fingers in the adjusting mechanism between the moving parts of the footrest.

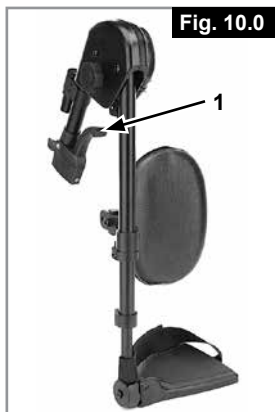

Adjusting the calf pad

The calf pad can be adjusted as follows:
 Height: Open bolt (4 Fig.13.0) and move the clamping piece to the desired position. By rotating the clamping piece also the angle can be adjusted.
 Depth: Open bolt (5) and move the calf pad into the desired position.
 Width: Open bolt (5) and position the spacers behind the pad, to get the desired position.

CAUTION!

Always make sure that the fasteners are secure.

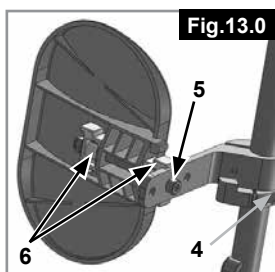

Options - Castors

Castors, castor plates, forks

The wheelchair may veer slightly to the right or left, or the castors may wobble. This may be caused by the following:

- Forward and/or reverse wheel motion has not been set properly.
- The castor angle has not been set correctly.
- Castor and/or rear wheel air pressure is incorrect; the wheels do not turn smoothly.

The wheelchair will not move in a straight line if the castors have not been properly adjusted. Castors should always be adjusted by an authorised dealer. The castor plates must be re-adjusted, and the wheel locks must be checked every time the rear wheel position has been altered.

The seat height is determined by the castor and rear wheel position. The seat height can be adjusted by altering the position of the rear wheels and the castors (see seat height matrix on page 14).

CAUTION!

After adjusting the seat height, all screws must be re-tightened and the wheel lock must be readjusted.

Options - Backrest

Height-adjustable backrest

The height of the back rest can be set to 3 different positions. Release and remove bolt (1) and move the upholstery to the desired position. Tighten up the bolts again. (Fig.14.0).

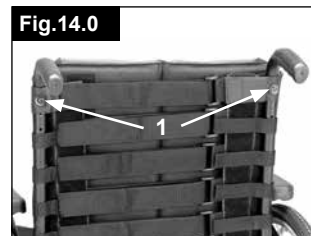

Half folding back

Unfolding the backrest:
 To put the backrest in the upright position, push the handles upwards and forwards until they lock in, (Fig.15.0).



WARNING!

Keep fingers and other items away from the folding mechanism when the backrest is being folded to prevent injury or damage to property.

Folding the backrest:

The backrest can be folded to make storage of the wheelchair easier, (Fig.17.0).

CAUTION!

Do not operate under load as this may cause lever to break.



To fold the backrest, stand behind the wheelchair, press the two small levers (Fig. 16.0) positioned on each side of the backrest (just above the armrests). Fold the backrest down.

Reclining back (4 -55°)

By pulling both levers together (1), you can release the backrest and then move it to the desired position (Fig. 17.0)

On releasing the two levers (1) the backrest will automatically lock into place

CAUTION!

The reclining backrest can only be used in conjunction with the wheelbase extension.

It is recommended that the reclining backrest is used in conjunction with anti-tip tubes (maximum ground clearance 30 - 50mm).

We recommend that the reclining backrest is used in conjunction with a stabilising bar.



Side guard, flip-up, removable with short or long armrests, height-adjustable

The armrest can be height-adjusted as follows.

Move the lever downwards and move the armrest to the desired height.

Release the lever and press the armrest downwards until you hear it click into place. Always check that the side guards are correctly in place.

To flip the armrest up, push the lever (1) so that the sideguard is released.



You can adjust the length of the armrest by releasing the screws (2) push the armrest to the desired position and then re-tighten the screws (Fig. 21.0).

CAUTION:

- Neither the sideguards nor the armrests are to be used for lifting or carrying the wheelchair.
- When using a 24" rear wheel the armpad must be moved one level up.

Options – Push handles

HEIGHT-ADJUSTABLE PUSH HANDLES

These handles are secured with pins to prevent them from sliding out unintentionally. By releasing the release lever (1) you can adjust the push handles to a height which suits you. After any adjustment to the height of the push handles, pull the release lever (1) until it is tight (Fig. 18.0).

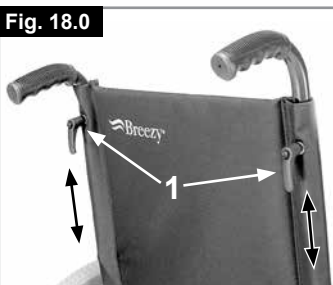

CAUTION:

If the lever is not secure, injuries could result when lifting over obstacles.

Options – sideguard

Standard side guard, flip-up, removable with short or long armrests

The sideguard with rounded off front edges will allow you to get up close to a table. To flip the armrest up, push the lever (1), so that the sideguard is released (Fig.19 + 20).



The height of the armrest (2) can be adjusted by fitting the spacer bracket in various positions. To do this release the screws, move the spacer bracket and re-tighten the screws. The length of the armrest can be adjusted by releasing the screws (3), then move the armrest to the desired position and re-tighten the screws (Fig.21.0).



CAUTION:

- Neither the sideguards nor the armrests are to be used for lifting or carrying the wheelchair.
- Take care of your fingers when adjusting the arm pad height.

Options - Anti-Tips

Anti-Tip Tubes

Anti-tip tubes provide additional safety for inexperienced users when they are still learning how to operate their wheelchair. They prevent a wheelchair from tipping over backwards, (Fig. 22.0).



By pushing on the release button (1), the safety wheels can be set upwards or removed. There must always be a gap of between 30mm and 50mm between the tube and the ground.

You must swing the safety wheels upwards when going up and down large obstacles (such as a kerb) to prevent them from touching the ground. Then rotate the safety wheels back down to the normal position.

WARNING!

Incorrect setup of the anti-tips will increase the risk of a rearwards tip.

Pelvic Restraint Belt



- Before using your wheelchair ensure the lap belt is worn.
- The lap belt must be checked on a daily basis to ensure it is free from any obstruction or adverse wear.
- Always make sure that the lap strap is correctly secured and adjusted prior to use. If the strap is too loose it could cause the user to slip down and risk suffocation or cause serious injury.

The lap belt is fitted to the wheelchair as shown in the illustrations. The seat belt comprises 2 halves. They are fitted using the existing seat stay retaining bolt fitted through the eyelet on the belt. The belt is routed under the rear of the side panel. (Fig. 23.0)

Adjust the belt position so buckles are in the centre of the seat. (Fig. 24.0)

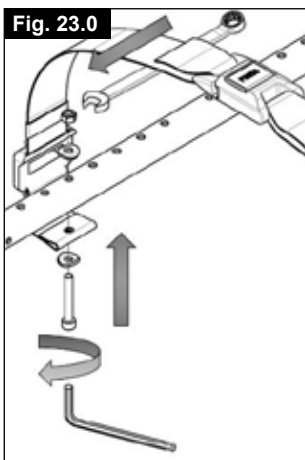

Adjust lap belt to suit the user's needs as follows:

To reduce the belt length	To increase the belt length
<p>Feed free belt back through male buckle and slide adjusters. Ensure belt is not looped at male buckle.</p>	<p>Feed free belt through slide adjusters and male buckle to provide more belt length.</p>

When fastened check space between the pelvic restraint belt and user. When correctly adjusted it should not be possible to insert more than the flat of the hand between the lap belt and the user. (Fig. 25.0)

The lap belt should be fixed so that the belt sits at an angle of 45 degrees across the user's pelvis. The user should be upright and be as far back as possible in the seat when correctly adjusted. The lap belt should not allow the user to slip down in the seat. (Fig.26.0)

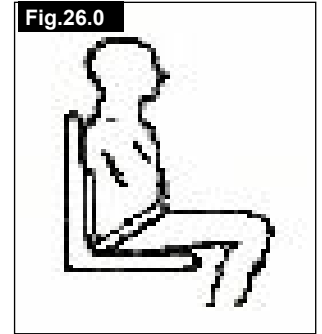

To fasten buckle:
Firmly push male buckle into female buckle.



To release belt:
Press exposed sides of male buckle and push towards centre whilst gently pulling apart.



- If in doubt about the use and operation of the lap belt then ask your healthcare professional, wheelchair dealer, carer or attendant for assistance.
- If you want to retrofit a lap belt, then please contact your authorised Sunrise Medical dealer.
- The lap belt must be checked on a daily basis to ensure it is adjusted correctly and free from any obstruction or adverse wear.
- Sunrise Medical does not encourage the transportation of any person in a vehicle using this lap belt as a method of restraint.



Please see Sunrise Medical transit booklet for further advice on transportation.

Maintenance:

Check lap belt and securing components at regular intervals for any sign of fraying or damage. Replace if necessary.



The lap belt should be adjusted to suit the end user as detailed above. Sunrise Medical recommends that the length and fit of the belt be checked on a regular basis to reduce the risk of the end user inadvertently re-adjusting the belt to an excessive length.

Options - Crutch holder

Crutch holder

This device permits crutches to be transported directly on a wheelchair. It has a Velcro loop to fasten crutches or other aids (Fig. 27.0).



WARNING!

Never try to use or attempt to remove the crutches or other aids while moving.

Options - Therapy Table

Therapy table

The tray provides a flat surface for most activities. Before using a tray, it first has to be adjusted to the width of the seat by an authorised dealer. The user must be sitting in the wheelchair during this adjustment (Fig. 28.0).

Maximum Load: 40kgs



Options – One Hand Operation

One Hand Operation (Fig.29.0 - 30.0)

To propel the chair straight forward both handrims must be used. To fold the wheelchair disconnect the telescopic bar by pushing the release inward (1). To take off the wheels pull release knob (2).

⚠ CAUTION!

Make always sure that the connections are set properly to avoid injuries.

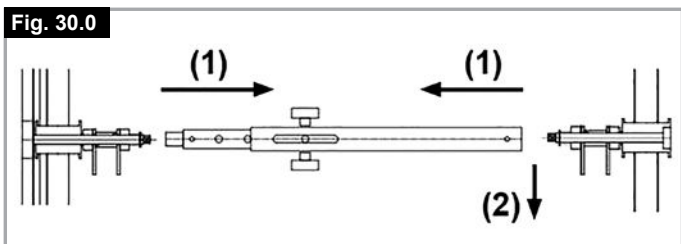

Additional Assembly Photographs



ANTI TIPS



HEADREST. NYLON SLING (ONLY FOR RECLINER OPTION)



STANDARD HEADREST



ANATOMICAL SHAPED HEADREST



HEAD REST 1

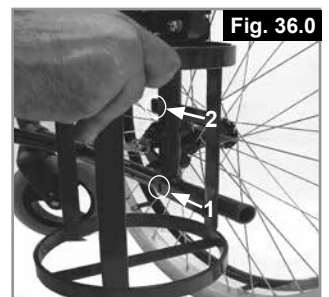

**TANK HOLDER
Maximum Load: 5kgs**

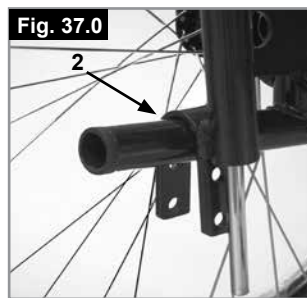

IV POLE 2

Tyres and Mounting

Tyres and mounting

Pneumatic tyres are fitted as standard from the factory.

If pneumatic tyres are used, make sure that you maintain the correct tyre pressure, as this can have an effect on wheelchair performance. If the tyre pressure is too low, rolling resistance will increase, requiring more effort to move the chair forward. Low tyre pressure also has a negative impact on manoeuvrability. If the tyre pressure is too high, the tyre could burst. The correct pressure for a given tyre is printed on the surface of the tyre itself.

Tyres can be mounted the same way as an ordinary bicycle tyre. Before installing a new inner tube, you should always make sure that the base of the rim and the interior of the tyre are free of foreign objects. Check the pressure after mounting or repairing a tyre. It is critical to your safety and to the wheelchair's performance that regulation air pressure be maintained and that tyres be in good condition.

Name Plate

Name Plate

The nameplate is located on either the cross-tube assembly or the transverse frame tube, as well as on a label in the owner's manual. The nameplate indicates the exact model designation and other technical specifications. Please provide the following pieces of information whenever you have to order replacement parts or to file a claim:

- Serial number
- Order number
- Month/Year

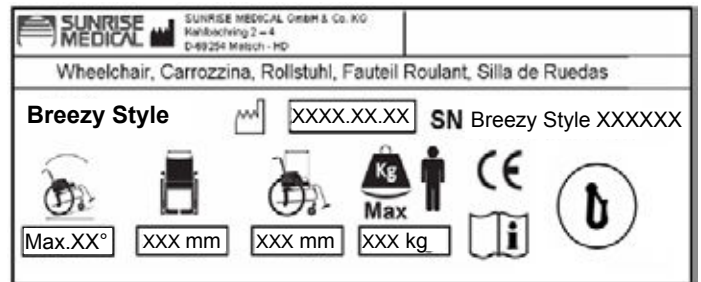

Breezy Style XXXXX-XXX	Product Name/SKU Number.
	Maximum safe slope with anti-tip tubes fitted, Depends on wheelchair setting, posture and physical capabilities of the user.
	Seat width.
	Depth (maximum).
	Load Maximum.
	CE Mark
	User's Guide.
	Crash Tested
	Not Crash Tested
	Date of manufacture.
SN RELXXXXXXXX	Serial number.

Maintenance and care

SAFETY CHECK:

As the user you will be the first person to notice any possible defects. We therefore recommend that before each use, you check the following:

The tyre pressure is correct.

The brakes work correctly.

All removable parts are securely fastened (e.g. armrests, footrest hangers, quick-release axles ...).

If there is any damage/defect, please contact your authorised dealer.

MAINTENANCE:

Check the tyre pressure at regular intervals.

Check all tyres for wear and damage at regular intervals, at least annually. Change the tyres as soon as there is any sign of damage or wear.

Check the seat and back sling for wear and damage at regular intervals, at least annually. Change these items as soon as there is any sign of damage or wear.

Check all frame and backrest components for wear and damage at regular intervals, at least annually. Change these items as soon as there is any sign of damage or wear.

Check the brakes for wear and damage at regular intervals, at least annually. Check that they are working properly and are easy to use. Change the brakes as soon as there is any sign of damage or wear. Check to make sure all bolts are secure (see the section on torque) at regular intervals, at least annually. All screws which are critical to using the wheelchair safely have safety nuts. Safety nuts should only be used once and should be replaced after use.

NOTE: If torque settings are given, then we strongly recommend that you use a torque measuring device, in order to check that you have tightened to the correct torque.

Please use only mild household cleaners when your wheelchair is dirty. Use only soap and water when cleaning the seat upholstery and lap belt.

Depending on the frequency and type of use, we recommend taking your wheelchair to your authorised dealer regularly, but at least within a year, to have it maintained by trained personnel.



CAUTION!

Sand, salt and sea water can damage the bearings of the front and rear wheels. Clean and dry the wheelchair carefully, after they have been exposed to these elements.

Trouble Shooting

Wheelchair pulls to one side

- Check tyre pressure (pneumatic tyres only).
- Check to make sure wheel turns easily (bearings, axle).
- Check the castor angles are set consistently and make proper contact with the ground.
- Ensure castor fork bearings rotate freely.

Castors begin to wobble

- Check the castor angle.
- Check to make sure all bolts are secure; tighten if necessary (see the section on torque).
- Check to make sure both castors are making proper contact with the ground.

Cross-tube assembly does not snap into position in the seat saddle

- Chair is still new, i.e. the seat or backrest upholstery is still very stiff. This will improve with time.

Wheelchair is difficult to fold up

- Adjustable backrest upholstery is too stiff. Loosen it accordingly.

Wheelchair squeaks and rattles

- Check to make sure all bolts are secure; tighten if necessary (see the section on torque).
- Apply small amount of lubrication to spots where movable parts come in contact with one another.

Wheelchair begins to wobble

- Check angle at which castors are set.
- Check all tyres for damage or wear.
- Check to see if rear wheels are adjusted or fixed unevenly.

Disposal / Recycling of Materials

NOTE: If the wheelchair has been supplied to you free of charge it may not belong to you. If it is no longer required follow any instructions given by the organisation issuing the wheelchair in order that it may be returned to them.

The following information describes the materials used in the wheelchair in relation to the disposal or re-cycling of the wheelchair and its packaging. Specific waste disposal or recycling regulations may be in force locally and these should be taken into consideration when disposal arrangements are made. (This may include the cleaning or decontamination of the wheelchair before disposal).

Aluminium: Side frames, armrests, frame, legrests..

Plastic: Handgrips, castor forks, tube plugs, castor wheels, footplates, armpads and 12" wheel/tyre, wheels, side guards.

Packaging: Low density polythene bag, cardboard box.

Upholstery: Woven polyester with PVC coatings and expanded combustion modified foam.

Disposal or recycling should be done through a licensed agent or authorised place of disposal. Alternatively your wheelchair may be returned to your dealer for disposal.



Technical Data

Technical Specifications

Overall width:

- | | |
|--|-------------|
| With standard wheels including handrims | SW +180 mm |
| With drumbrake wheels including handrims | SW + 200 mm |

Folded dimensions:

- with rear wheels approx. 275 mm (for 24")
- without rear wheels approx. 220 mm

Weight in kg:

- Transportation (without footrest, wheels, sideguard) 7.6 kg
- Footrest (unit) 0.650 kg
- Sideguard (unit) 0.750 kg
- Wheels (unit) 1.75 kg

Maximum user weight:

- Breezy Style up to a load of 125 kg

MAXIMUM LOAD: 125 KG

According EN12183: 2009 all there listed parts (seat - back upholstery, arm pad, side panel...) are fire resistant according EN1021 Part 1/2 .

The Dynamic safe slope is dependant on the chair configuration, the users abilities and the style of riding. As the users abilities and style of riding cannot be pre-determined then the max safe slope cannot be determined. Therefore this must be determined by the user with the assistance of an attendant to prevent tipping. It is strongly recommended that inexperienced users have Ant-tips fitted. The wheelchair conforms to the following standards:

- a) Requirements and test methods for static, impact and fatigue strengths (ISO 7176-8)
- b) Requirements for resistance to ignition in accordance with ISO 7176-16 (EN 1021-1/2)







- UK = www.SunriseMedical.co.uk
- DE = www.SunriseMedical.de
- FR = www.sunrisemedical.fr
- IT = www.SunriseMedical.it
- NL = www.SunriseMedical.nl
- ES = www.SunriseMedical.es
- PT = www.SunriseMedical.pt
- SE = www.SunriseMedical.se
- NO = www.SunriseMedical.no
- DK = www.SunriseMedical.dk
- CH = www.SunriseMedical.ch
- CZ = www.medicco.cz
- PL = www.Sunrise-Medical.pl
- EU = www.SunriseMedical.eu
- AU = www.sunrisemedical.com.au
- US = www.SunriseMedical.com

